

**433

*224

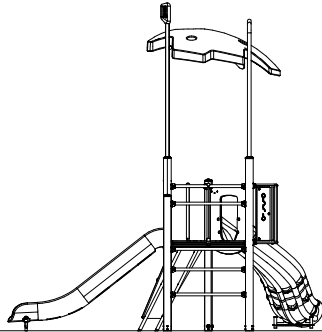

PCE112102
1:100